

EN

OPERATING MANUAL
LASER DISTANCE MEASURING
DEVICE

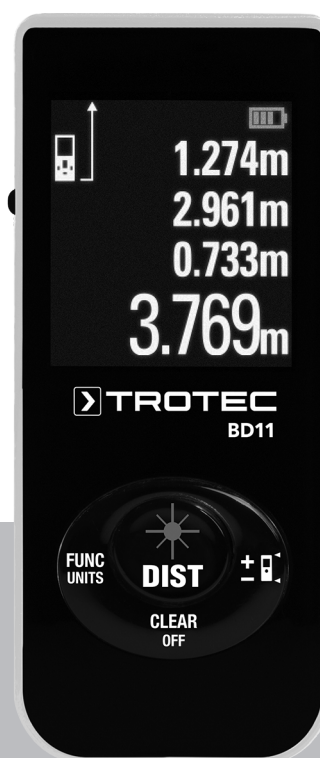

Table of contents

Notes regarding the operating manual..... 2

Safety 2

Information about the device..... 4

Transport and storage..... 6

Operation 7

Maintenance and repair 10

Errors and faults..... 10

Disposal 11

Notes regarding the operating manual

Symbols

 **Warning of electrical voltage**
 This symbol indicates dangers to the life and health of persons due to electrical voltage.

 **Warning of laser radiation**
 This symbol indicates dangers to the health of persons due to laser radiation.

 **Warning**
 This signal word indicates a hazard with an average risk level which, if not avoided, can result in serious injury or death.

 **Caution**
 This signal word indicates a hazard with a low risk level which, if not avoided, can result in minor or moderate injury.

Note
 This signal word indicates important information (e.g. material damage), but does not indicate hazards.

 **Info**
 Information marked with this symbol helps you to carry out your tasks quickly and safely.

 **Follow the manual**
 Information marked with this symbol indicates that the operating manual must be observed.

You can download the current version of the operating manual and the EU declaration of conformity via the following link:



BD11



<https://hub.trotec.com/?id=41856>

Safety

Read this manual carefully before starting or using the device. Always store the manual in the immediate vicinity of the device or its site of use.

-  **Warning**
Read all safety warnings and all instructions. Failure to follow the warnings and instructions may result in electric shock, fire and/or serious injury.
Save all warnings and instructions for future reference.
 This appliance can be used by children aged from 8 years and above and persons with reduced physical, sensory or mental capabilities or lack of experience and knowledge if they have been given supervision or instruction concerning use of the appliance in a safe way and understand the hazards involved.
 Children shall not play with the appliance. Cleaning and user maintenance shall not be made by children without supervision.
- Do not use the device in potentially explosive rooms or areas and do not install it there.
 - Do not use the device in aggressive atmosphere.
 - Do not immerse the device in water. Do not allow liquids to penetrate into the device.
 - The device may only be used in dry surroundings and must not be used in the rain or at a relative humidity exceeding the operating conditions.
 - Protect the device from permanent direct sunlight.
 - Do not remove any safety signs, stickers or labels from the device. Keep all safety signs, stickers and labels in legible condition.
 - Do not open the device.
 - Avoid looking directly into the laser beam.
 - Never point the laser beam at people or animals.

- Only use the device, if sufficient safety precautions were taken at the surveyed location (e.g. when performing measurements along public roads, on building sites etc.). Otherwise do not use the device.
- Observe the storage and operating conditions as given in the Technical data chapter.

Intended use

Only use the laser distance measuring device BD11 for measuring distances, areas and volumes by means of the integrated laser and within the measuring range specified in the technical data. Observe and comply with the technical data.

To use the device for its intended use, only use accessories and spare parts which have been approved by Trotec.

Improper use

Do not use the device in potentially explosive atmospheres, or for measurements in liquids. Never point it at people or animals. Trotec accepts no liability for damages resulting from improper use. In such a case, any warranty claims will be voided.

Any unauthorised modifications, alterations or structural changes to the device are forbidden.

Personnel qualifications

People who use this device must:

- be aware of the dangers that occur when working with laser measuring devices.
- have read and understood the operating manual, especially the Safety chapter.

Residual risks



Warning of electrical voltage

There is a risk of a short-circuit due to liquids penetrating the housing!
Do not immerse the device and the accessories in water. Make sure that no water or other liquids can enter the housing.



Warning of electrical voltage

Work on the electrical components must only be carried out by an authorised specialist company!



Warning of explosive substances

Do not expose the battery to temperatures above 45 °C! Do not let the battery come into contact with water or fire! Avoid direct sunlight and moisture. There is a risk of explosion!



Warning of laser radiation

Laser class 2, P max.: < 1 mW, λ: 400-700 nm, EN 60825-1:2014

Do not look directly into the laser beam or the opening from which it emerges.

Never point the laser beam at people, animals or reflective surfaces. Even brief eye contact can lead to eye damage.

Examining the laser output aperture by use of optical instruments (e.g. magnifying glass, magnifiers and the like) entails the risk of eye damage.

When working with a laser of class 2, observe the national regulations on wearing eye protection.



Warning

Risk of suffocation!

Do not leave the packaging lying around. Children may use it as a dangerous toy.



Warning

The device is not a toy and does not belong in the hands of children.



Warning

Dangers can occur at the device when it is used by untrained people in an unprofessional or improper way! Observe the personnel qualifications!



Caution

Lithium-ion batteries might catch fire in case of overheating or damage. Ensure a sufficient distance to heat sources, do not subject lithium-ion batteries to direct sunlight and make sure not to damage the casing. Do not overcharge lithium-ion batteries. Only use smart chargers that switch off automatically when the battery is fully charged. Charge lithium-ion batteries in due time before they are discharged completely.



Caution

Keep a sufficient distance from heat sources.

Note

To prevent damages to the device, do not expose it to extreme temperatures, extreme humidity or moisture.

Note

Do not use abrasive cleaners or solvents to clean the device.

Information about the device

Device description

The laser distance measuring device BD11 is used to determine distances, areas and volumes in interior spaces. Indirect measurements are carried out employing the Pythagoras function.

The multi-line, illuminated display indicates the determined values.

Owing to the dust- and splash-proof housing (IP54), the device is also suited for use on construction sites.

Measuring distance

The range of the device can be gathered from the Technical data chapter. Under certain conditions – e.g. at night, in twilight or when the target is hidden in the shade – greater distances are possible even without target plate. During the day use a target plate to increase the distance for poorly reflecting targets.

Target surfaces

There might be measurement errors when the laser encounters colourless liquids (e.g. water), dust-free glass, styrofoam or other semi-permeable materials. The measurement result may also be falsified if the laser encounters a high-gloss surface and is deflected by it. Non-glossy, non-reflective or dark surfaces can extend the measurement duration.

Device depiction

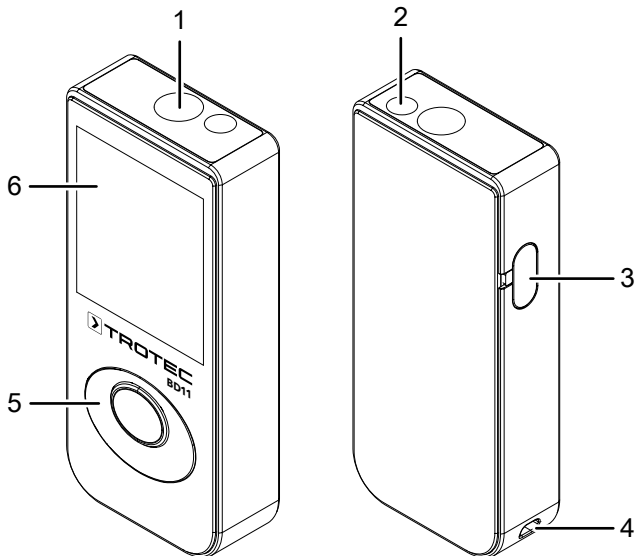

No.	Designation
1	Optical sensor
2	Laser
3	Mini USB port (for charging)
4	Eyelet for wrist strap
5	Operating elements
6	Display

Operating elements

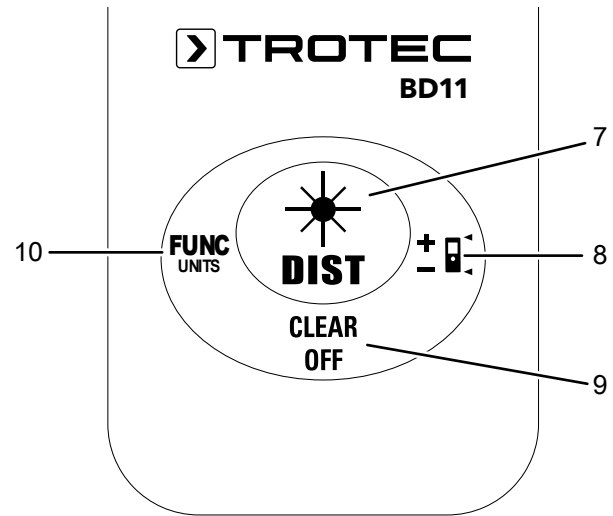

No.	Operating element	
7	Press briefly once / twice: (depending on the model version)	Switch-on button
	Press briefly:	Measurement button
	Press for a long time:	Button for permanent distance measurements
8	Press briefly:	Plus / minus button
	Press for a long time:	Reference button
9	Press briefly:	Delete button
	Press for a long time:	Switch-off button
10	Press briefly:	Function button (area, volume or indirect measurement)
	Press for a long time:	Unit button (ft, in, m)

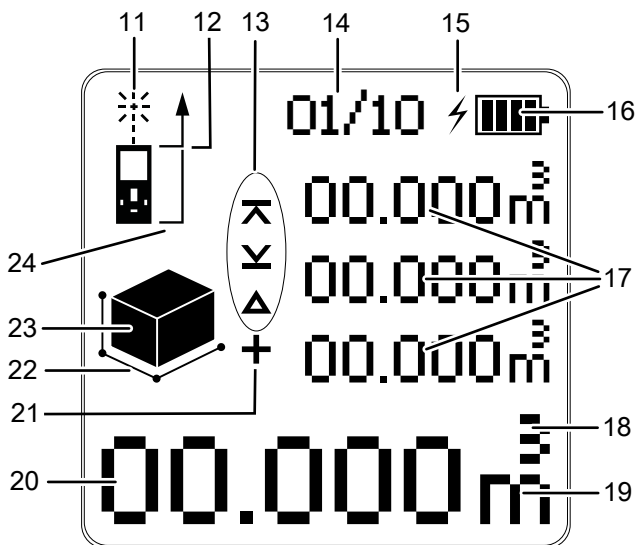

Display



No.	Display element
23	Measuring mode indication: Area measurement Volume measurement Indirect measurement (two auxiliary measurements) Indirect measurement (three auxiliary measurements)
24	Reference value rear

No.	Display element
11	Laser active
12	Reference value front
13	Symbols for non-stop / min / max measurement: Measured maximum value Measured minimum value Delta = maximum minus minimum
14	History indication
15	Charging symbol indication
16	Battery status
17	Measurement value display top section: The three upper measurement value displays show the past three measured values, the minimum and maximum value or the measured values to be added or subtracted.
18	Additional indication for units of area and volume
19	Display of the selected unit. Possible units are: ft, ft ² , ft ³ , in, m, m ² , m ³
20	Measurement value display bottom section: The lower measurement value display indicates the last measured value or the result of a calculation.
21	Indication for addition and subtraction
22	Indication of lines to be measured

Technical data

Parameter	Value
Model:	BD11
Weight:	23.8 g
Dimensions (H x W x D):	74.5 x 33.9 x 14.7 mm
Measuring range:	0.05 to 30 m / 0.17 to 98 ft
Accuracy:	± 3 mm*
Measuring range resolution:	1 mm
Number of recordings logged in the history:	10
Type of protection:	IP54
Operating temperature:	0 °C to 40 °C
Storage temperature:	-20 °C to 70 °C
Laser output:	< 1 mW (620–690 nm)
Laser class:	II
	10 mm / 10 m 12 mm / 20 m 20 mm / 30 m
Automatic switch-off of the device:	After approx. 3 minutes of non-use
Automatic switch-off of the laser:	After approx. 30 seconds of non-use
*under favourable conditions (good target surface, room temperature) up to 30 m	
Battery (integrated)	
Type	Li-ion
Nominal voltage	3.7 V  , 200 mAh
Charging voltage	5 V  , 500 mA

Scope of delivery

- 1 x Laser distance measuring device BD11
- 1 x Wrist strap
- 1 x Mini USB charging cable
- 1 x Manual

Transport and storage

Note

If you store or transport the device improperly, the device may be damaged.

Note the information regarding transport and storage of the device.

Transport

For transporting the device, use the bag included in the scope of delivery in order to protect the device from external influences.

The supplied Li-ion batteries are subjects to the requirements of dangerous goods legislation.

Observe the following when transporting or shipping Li-ion batteries:

- The user may transport the batteries by road without any additional requirements.
- If transport is carried out by third parties (e.g. air transport or forwarding company), special requirements as to packaging and labelling must be observed. This includes consulting a dangerous goods specialist when preparing the package.
 - Only ship batteries if their housing is undamaged.
 - Please also observe any other national regulations.

Storage

When the device is not being used, observe the following storage conditions:

- dry and protected from frost and heat
- protected from dust and direct sunlight
- with a cover to protect it from invasive dust if necessary
- The storage temperature is the same as the range given in the Technical data chapter.

Operation

Switching the device on



Warning of laser radiation

Laser class 2, P max.: < 1 mW, λ: 400-700 nm, EN 60825-1:2014

Do not look directly into the laser beam or the opening from which it emerges.

Never point the laser beam at people, animals or reflective surfaces. Even brief eye contact can lead to eye damage.

Examining the laser output aperture by use of optical instruments (e.g. magnifying glass, magnifiers and the like) entails the risk of eye damage.

When working with a laser of class 2, observe the national regulations on wearing eye protection.

1. Depending on the model version, briefly press the Switch-on / measurement button (7) once or twice.
 - ⇒ The display will be switched on and the device ready for operation.

Switch-off

1. Press the Switch-off button (9) for a long time.
 - ⇒ The display is switched off.

Basic settings

Aborting the measurement and deleting the display

Briefly press the Delete button (9) to abort the current measurement or to delete the displayed measured values one at a time. The laser switches off for this purpose.

Setting the reference value

The device always measures the total distance starting at the reference point. This means that if the rear end of the device is set as reference point, the length of the device will be part of the measurement. By default the reference point is set to the rear of the device. You can, however, also relocate the reference point to the front part of the device.

To do so, please proceed as follows:

1. Press the Reference button (8) for a long time to relocate the reference point to the front end of the device.
 - ⇒ The Reference value front indication (12) appears on the display.
2. Press the Reference button (8) for a long time once again to relocate the reference point to the rear end of the device.

When switching the device off and then on again, the reference value will automatically be relocated to the rear end of the device.

Changing the units

1. Press the Unit button (10) for a long time to switch between the units for the measured values. Available units are **ft**, **in** and **m**.

Calling up a measured value in the device history

The device automatically saves the last 10 measured values.

The saved measured values can be called up as follows:

1. Briefly press the Function button (10) five times to call up the history.
 - ⇒ The History indication (14) appears on the display.
2. Briefly press the Plus / minus button (8) to navigate through the history and call up the saved measured values.
 - ⇒ In the History indication (14) you can see which saved measured value is currently displayed.
3. You can return to the normal measuring menu by briefly pressing the Delete button (9).
4. By briefly pressing the Measurement button (7) you can use the saved value for your current measurement.

Carrying out measurements



Warning of laser radiation

Laser class 2, P max.: < 1 mW, λ: 400-700 nm, EN 60825-1:2014

Do not look directly into the laser beam or the opening from which it emerges.

Never point the laser beam at people, animals or reflective surfaces. Even brief eye contact can lead to eye damage.

Examining the laser output aperture by use of optical instruments (e.g. magnifying glass, magnifiers and the like) entails the risk of eye damage.

When working with a laser of class 2, observe the national regulations on wearing eye protection.



Info

Please note that moving from a cold area to a warm area can lead to condensation forming on the device's circuit board. This physical and unavoidable effect can falsify the measurement. In this case, the display shows either no measured values or they are incorrect. Wait a few minutes until the device has become adjusted to the changed conditions before carrying out a measurement.



Info

For a correct measurement, please observe the distances from the measuring object stated in the technical data. If the reference point is less than 0.05 metres away from the measuring object, the device will not perform a measurement.

Carrying out single distance measurement

1. Briefly press the Switch-on / measurement button (7) to activate the laser if it is switched off.
2. Point the laser at the target area.
3. Briefly press the Switch-on / measurement button (7) again to perform a distance measurement.
 - ⇒ The measured value is displayed in the lower measurement value display (20) immediately.

Adding / subtracting measured values

1. Carry out a single distance measurement.
 - ⇒ The measured value is indicated on the display.
2. To add a measured value, briefly press the Plus / minus button (8) one time.
3. To subtract a measured value, briefly press the Plus / minus button (8) twice.
4. Press the Switch-on / measurement button (7) to determine the next measured value.
 - ⇒ The overall result will be indicated in the lower measurement value display (20). The individual measured values will be indicated in the upper measurement value displays (17).

Performing an area measurement

1. Briefly press the Function button (10) one time.
 - ⇒ The symbol  for area measurement appears on the display.
2. Briefly press the Switch-on / measurement button (7) to carry out the first measurement (e.g. length).
 - ⇒ The measured value is indicated in the upper measurement value display (17).
3. Briefly press the Switch-on / measurement button (7) again to carry out the second measurement (e.g. width).
 - ⇒ Upon pressing the Switch-on / measurement button (7) for the second time the device calculates the area and displays this value in the lower measurement value display (20). The most recently measured value will be indicated in the upper measurement value display (17).

Performing a volume measurement

1. Briefly press the Function button (10) twice.
 - ⇒ The symbol  for volume measurement appears on the display.
 - ⇒ The side to be measured is indicated by red arrows in the measurement value display.
2. Briefly press the Switch-on / measurement button (7) to carry out the first measurement (e.g. length).
 - ⇒ The measured value is displayed in the upper measurement value display (17).
3. Briefly press the Switch-on / measurement button (7) again to carry out the second measurement (e.g. width).
 - ⇒ The measured value is additionally displayed in the upper measurement value display (17).

4. Briefly press the Switch-on / measurement button (7) again to carry out the third measurement (e.g. height).
 - ⇒ The measured value is additionally displayed in the upper measurement value display (17).
 - ⇒ Upon pressing the Switch-on / measurement button (7) for the third time the device independently calculates the volume and displays this value in the lower measurement value display (20).

Performing a non-stop / min and max measurement

Use the non-stop measuring function to correlate measurements e.g. with construction drawings. With this measurement method the device can be moved closer toward the target with the measured value being recalculated roughly every 0.5 seconds. The corresponding maximum and minimum measured values are displayed in the first and second line of the upper measurement value display (17) respectively.

For instance, you can direct the laser beam at a wall and then retreat from it step by step. Keep reading the measured values until the desired distance is achieved.

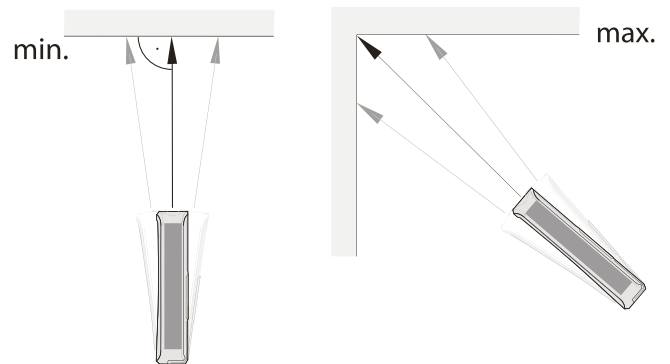

1. Press and hold the Switch-on / measurement button (7) for approx. 2 s.
 - ⇒ The indications ∇ , ∇ and Δ (13) appear on the display.
2. With reference to the target point, move the device slowly back and forth as well as up and down (e.g. in a corner).
3. Briefly press the Switch-on / measurement button (7) to terminate the non-stop measurement.
 - ⇒ The maximum and minimum measured values and the difference Δ (13) between these two are indicated on the display. Additionally, the last measured value will be displayed in the lower measurement value display (20).

Indirect height measurement (Pythagoras)

Using this method the length of an unknown straight-line segment can be determined via the Pythagorean Theorem. This method is suitable for e.g. height measurements.

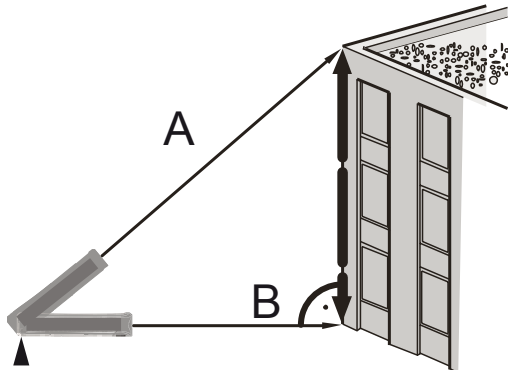

Measurement requirements:

- The device is aligned horizontally to the lowest point (B) of the line segment to be determined.
- The reference point is located at the rear of the device. See chapter Setting the reference value.

1. Briefly press the Function button (10) three times.

- ⇒ The symbol  for indirect measurements appears on the display.
- ⇒ The bar for the hypotenuse is marked in red.

2. Aim the device at the highest point (A) and briefly press the Switch-on / measurement button (7) once to perform a measurement. Make sure to hold the device as steady as possible and place it level on the ground with the two rear edges. **The position at the two rear edges must not be changed during the measurements!**

- ⇒ The length of the line segment will be indicated in the 1st line of the upper measurement value display.
- ⇒ The bar for the horizontal leg is marked in red.

3. Align the device horizontally (point B) and briefly press the Switch-on / measurement button (7) one time to measure the horizontal distance.

- ⇒ The second measured value will be indicated in the second line of the upper measurement value display.
- ⇒ The line segment to be determined is displayed as result in the lower measurement value display (20).

Twofold indirect height measurement

This method is suitable for e.g. height measurements.

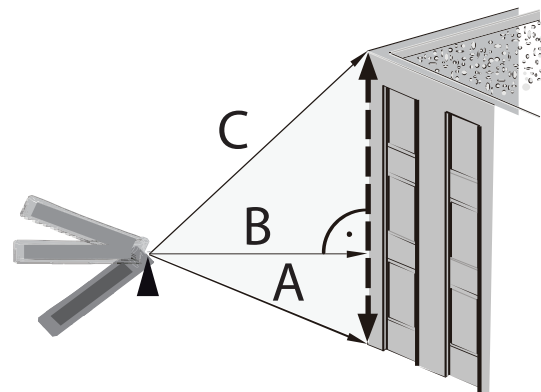

1. Briefly press the Function button (10) four times.

- ⇒ Line C is marked in red.

2. First, aim the device at the highest point (C) and briefly press the Switch-on / measurement button (7) once to perform a measurement. In doing so, hold the device as steady as possible. **The alignment of the device in relation to the reference point must not be changed during the measurements!**

- ⇒ The first measured value will be displayed in the upper measurement value display.
- ⇒ Line B is marked in red.

3. Align the device horizontally (B) and briefly press the Switch-on / measurement button (7) one time to measure the horizontal distance.

- ⇒ The second measured value will be indicated in the second line of the upper measurement value display.
- ⇒ Line A is marked in red.

4. Aim the device at the lowest point (A) and briefly press the Switch-on / measurement button (7) once to perform a measurement.

- ⇒ The third measured value will be indicated in the third line of the upper measurement value display.

- ⇒ The line segment to be determined is displayed as result in the lower measurement value display (20).

Maintenance and repair

Charging the battery

The battery should be charged when the battery is low. The battery power is shown on the display (6) in the battery status indication (16). Proceed as follows:

1. Open the rubber side cover.
2. Connect the mini USB cable to the device.

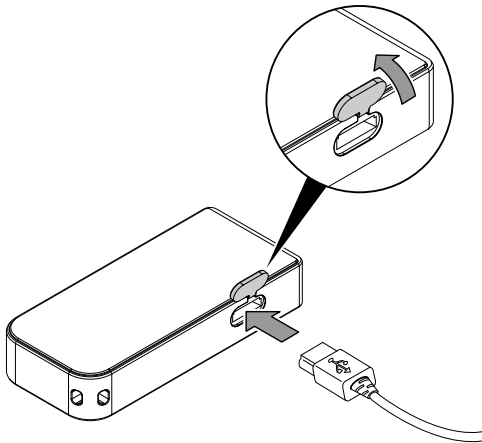

3. The charging symbol (15) is shown on the display (6). When the battery is fully charged, the battery symbol in the battery status indication (16) is completely green.

Cleaning

Clean the device with a soft, damp and lint-free cloth. Make sure that no moisture enters the housing. Do not use any sprays, solvents, alcohol-based cleaning agents or abrasive cleaners, but only clean water to moisten the cloth.

Repair

Do not modify the device or install any spare parts. For repairs or device testing, contact the manufacturer.

Errors and faults

The device has been checked for proper functioning several times during production. If malfunctions occur nonetheless, check the device according to the following list.

Icon	Cause	Remedy
	The battery is almost empty.	Recharge the battery.
	Calculation error	Repeat the measurement. Pay attention to the measurement sequence and position of the device.
	The temperature is too high.	Allow the device to cool down. Observe the permissible operating temperature according to the Technical data chapter.
	The temperature is too low.	Allow the device to warm up. Observe the permissible operating temperature according to the Technical data chapter.
	The reception of the reflected signal is too strong or too weak.	Repeat the measurement on another surface with better reflective properties or use a target plate.
	The ambient light is too intense.	Change the ambient light conditions for the measurement.
	Hardware fault	Repeatedly switch the device on and off. If the symbol does not disappear, please contact your retailer.